



# Dry Compression Rotary Screw Compressors

**CSG-2 Series**

Flow rate up to 13.75 m<sup>3</sup>/min, Pressure 4, 6, 8 and 10 bar

# Durable and clean-running for sensitive processes

Two-stage dry compression rotary screw compressors from KAESER not only impress with their intelligent component layout, but also with their many innovative details – all of course with the renowned KAESER quality and distinctive, contemporary design. Whether they are being used in the semiconductor, foodstuff or automotive industries, our two-stage dry-running compressors tirelessly prove that process-appropriate purity and cost-effectiveness really can go hand in hand – even in adverse conditions.

## Long-term efficiency

Compressed air simply has to be available whenever it is needed. KAESER dry compression rotary screw compressors are therefore built to last, ensuring many years of dependable performance. Comprising tried and tested components developed as a result of KAESER KOMPRESSOREN's near century of experience in mechanical engineering, they deliver durability and compressed air availability to meet even the toughest of demands.

## Innovation you can trust

Using all of the advantages that KAESER's advanced Research and Development Centre in Coburg has to offer, KAESER engineers designed every detail of the two-stage dry compression rotary screw airend with maximum efficiency and performance in mind. Further innovative details include the use of fibre-free pulse dampers and, on water-cooled compressor systems, an integrated heat recovery module.

## Efficiency as standard

KAESER quality and expertise really count when it comes to those all-important overall system costs for asset investments, such as compressors or complete compressed air supply systems. Lowest possible compressed air costs and maximum availability can be guaranteed only through a combination of perfect interplay between energy efficiency and service/maintenance, and by viewing the compressed air supply system as a whole.

## Service-friendly

Right from the outset, these versatile systems were designed for maximum ease of servicing. Fewer wearing parts and the use of premium-quality materials ensure reduced maintenance requirement, longer service intervals and extended service life. Excellent component accessibility, thanks to generously-sized maintenance doors and a swing-out cooler, are just some of the features that make servicing so effortless.

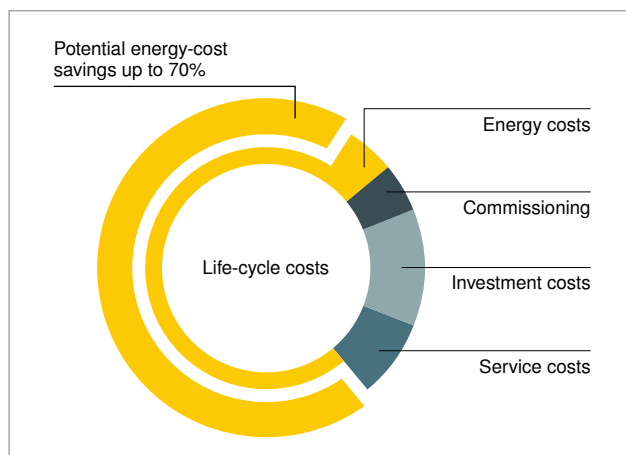

## Energy efficiency: the essential requirement

Investment and service costs account for only a small part of a compressor's total life-cycle costs. Since energy accounts for the lion's share of those costs, it's wise to save with KAESER Life-Cycle Management. KAESER has been committed to minimising your energy costs for compressed air production for over 40 years. We also have the bigger picture in clear focus when it comes to service and maintenance, as well as maximum compressed air supply availability.

# Contents



## CSG-2

Drive systems .....	04-05
Controller .....	06-07
Service-friendly design .....	08-09
Compressors with air-cooling .....	10-11
Compressors with water-cooling.....	12-13

## Heat recovery

Why recover heat?.....	14-15
Technical implementation of integrated heat recovery .....	16-17

## Compressed air drying

Process technology - Overview .....	18-19
Compressors with integrated refrigeration dryer.....	20-21
Compressors with integrated rotation dryer.....	22-25

## Functional diagrams and technical specifications

Compressors with air-cooling .....	26-27
Compressors with water-cooling.....	28-29

## Equipment and options

Equipment .....	30
Options .....	31

# Efficient drive systems

## Fixed speed, fixed flow rate.

### CSG-2 base load

Base load compressors from KAESER are designed to run at one optimal operating speed. Operating at the highest levels of efficiency, they deliver a constant air volume at a fixed motor speed, making them ideally suited for applications with a constant or lightly fluctuating air demand.

### Committed to meeting your objectives

CSG-2 base load compressors stand out for their functional, durable drive technology and supreme levels of efficiency.



### Super Premium Efficiency IE4

When it comes to base load compressors, SUPER PREMIUM EFFICIENCY IE4 asynchronous motors guarantee the highest possible efficiency levels, thanks to their well-established, durable technology and renowned service-friendliness.

## Variable speed, variable flow rate.

### CSG-2 peak load

Maximum flexibility and sustainability: thanks to their variable-speed drive motors, CSG-2 peak load compressors from KAESER always deliver the exact volume of compressed air actually required. This means that they are particularly efficient in applications with a varying air demand.

### Committed to meeting your objectives

CSG-2 peak load compressors stand out for their extremely high levels of flexibility when it comes to air delivery volumes. Fitted with synchronous reluctance motors, they guarantee a high level of efficiency across the whole air delivery range.



### Perfect teamwork - IES2

In the case of compressors with variable speed control, motor and frequency converter must work together in harmony in order to operate efficiently. For this reason, KAESER selects SIEMENS reluctance motors with specifically-matched frequency converters so as to guarantee perfect interplay at the highest levels of efficiency – IES 2.



### **Resource-conserving and service-friendly**

The synchronous reluctance motors fitted by KAESER are designed to conserve resources. Specially-formed magnetic steel sheets replace aluminium, copper and expensive rare earth materials. This makes the drive not only highly durable, but also service-friendly.



### **Efficient and economical**

Synchronous reluctance motors score high marks for efficiency across the whole speed range. This helps to save both energy and costs, even during partial load operation.

SIGMA CONTROL® 2 and SIGMA AIR MANAGER® 4.0

## Perfect interplay



### SIGMA CONTROL 2: Optimum efficiency

The internal SIGMA CONTROL 2 controller ensures efficient compressor control and monitoring at all times. The large display and RFID reader provide easy communication and maximum security. Variable interfaces enable seamless networking capability, whilst the SD card slot makes updates quick and easy.



### Integrated web server

The SIGMA CONTROL 2 is equipped with its own web server, making it possible to visualise compressor status via intranet or Internet. Operational data and maintenance/ alarm messages can therefore be viewed, with password protection, from any PC running a standard Internet browser. This feature benefits users considerably by simplifying operation and maintenance.





### **SIGMA AIR MANAGER 4.0**

This powerful master controller provides efficient control and coordinated management of up to 16 pieces of compressed air supply equipment, whilst also monitoring the associated air treatment components. The SIGMA AIR MANAGER 4.0 also ensures full compatibility of all KAESER compressed air supply systems within an Industrie 4.0 environment.



### **KAESER CONNECT**

The SIGMA AIR MANAGER 4.0's integrated web server provides visual display of all compressed air system data in the form of HTML pages. The information is available any time, anywhere, and can be visualised in real-time on all network-capable devices.

# Service...

## ...virtually maintenance-free



### (1) Hydraulic inlet valve

The hydraulically-operated inlet valves in KAESER dry compressing rotary screw compressors are unaffected by contaminants and condensate. This enhances their reliability and ease of maintenance when compared to pneumatic valves.



### (2) Fibre-free pulse dampers

KAESER's new fibre-free pulse dampers keep pressure losses to an absolute minimum, help maintain consistent air quality and minimise unwanted vibrations. In addition, their fibre-free design reliably eliminates the possibility of compressed air contamination.



Image: CSG 120-2 RD SFC W



## ...excellent accessibility



### (3) Easy-access coupling

The electric motor directly drives the airend via a maintenance-free coupling, which virtually eliminates transmission losses. Since there is no need for complicated disassembly work, the easy-access coupling can be replaced quickly and easily.



### (4) High-efficiency condensate separator

Thanks to its flow-optimised design, the newly developed condensate separator reliably separates the condensate downstream from the air coolers – with minimal pressure loss.





### **Cleaning made simple**

Thoroughly cleaning the air coolers does not require the use of a crane – they can simply be swung out by a service technician. Cleaning can then be carried out quickly and easily beside the machine, without the risk of contaminating the interior of the compressor unit.



### **Capable of operation in ambient temperatures up to +45 °C as standard**

Air-cooled CSG machines operate dependably in ambient temperatures up to +45 °C, thanks to their durable and energy-efficient radial fan.



## Air-cooling

Dependable performance – even under extreme conditions

### The benefits:

- No cooling-water infrastructure is required.
- Meticulously designed machines with logical component layout make maintenance and service work quick and easy.
- The heated cooling air can be easily re-used for space-heating purposes.

◀ Image: CSG 120-2 A



### Outstanding durability through pre-cooling

Highly effective pre-cooling with a stainless steel tube cooler on the high pressure side ensures outstanding air cooler durability. Furthermore, this robust cooler combination also delivers comparably low compressed air discharge temperatures.



### Energy-saving standstill fan

When the large radial fan in air-cooled CSG units is switched off as part of the transition to standby mode, the energy-saving, temperature-controlled standstill fan reliably removes any residual heat from the compressor.



# Water-cooling

## Compact energy-savers

### The benefits:

- Exceptionally low compressed air discharge temperature thanks to high-quality separate air cooler.
- Load-dependent cooling-water control for optimum compressor cooling and simultaneous efficient use of cooling-water.
- Compact, low-standing design.



Image: CSG 120-2 RD W SFC ▶



### Parallel heat exchanger

Both the low and high pressure stages of water-cooled KAESER dry compression rotary screw compressors are equipped with their own dedicated parallel heat exchanger for enhanced heat transfer. This optimised cooling consequently improves specific power performance.



### Optimised water cooler

Water-cooled CSG compressors feature highly efficient air/water heat exchangers. CuNi10Fe cooling pipes with internal star lamella fins provide optimum heat transfer and lowest possible compressed air discharge temperatures with minimal pressure loss.

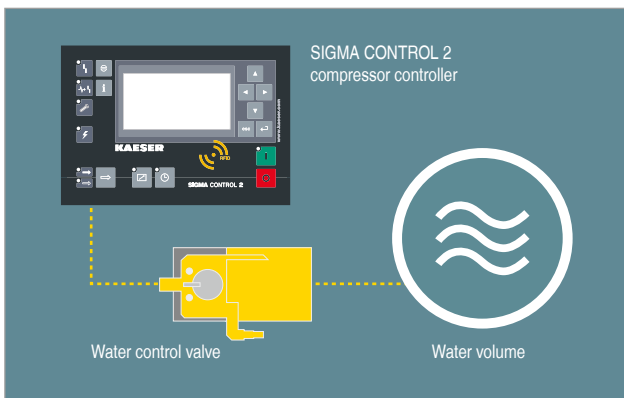

### Clever control

Water-cooled CSG-2 compressors feature sealed water control valves that are actuated via the advanced SIGMA CONTROL 2 compressor controller, which precisely adjusts the volume of water to meet the actual load requirement.



### Permanent adjustment

The important but time-consuming task of performing hydraulic adjustment on both air coolers is carried out permanently and automatically during commissioning and whilst the machine is in operation. Cooling performance is therefore optimally matched to the operating conditions.



# Why recover heat?

In fact, the question should be: Why not?

You will not only reduce your company's primary energy consumption, but also reduce its CO<sub>2</sub> balance.

## Compressors with air-cooling

Compressed air users need to develop clever ideas regarding the use of warm exhaust air from their compressors. KAESER has the long-standing expertise to help you with all you need to know in this regard and will stand side-by-side with you every step of the way.

## Compressors with water-cooling

Thanks to the compact heat recovery module integrated into the compressor, generating hot water for production or auxiliary heating purposes could not be simpler. Cost and space-intensive external infrastructure is not necessary with KAESER solutions and the amortisation period of the heat recovery module is usually less than a year (see example calculation below).



Example amortisation calculation	
Inlet temperature	20 °C
Relative humidity	30 %
Cooling water inlet (primary)	20 °C
Cooling water outlet (primary)	80 °C
Compressor power consumption CSG-130-2 10 bar (g)	96.8 kW
Heat recovery potential based on total power consumption	87 %
Recoverable heat capacity	84.2 kW
Annual operating hours	6,000 hrs
Kilowatt hours per year	505,296 kWh
Fuel costs	0.02 €/kWh
Annual fuel cost savings	€ 10,105
<b>Amortisation period</b>	<b>&lt; 1 year</b>

# Amortisation period < 1 year

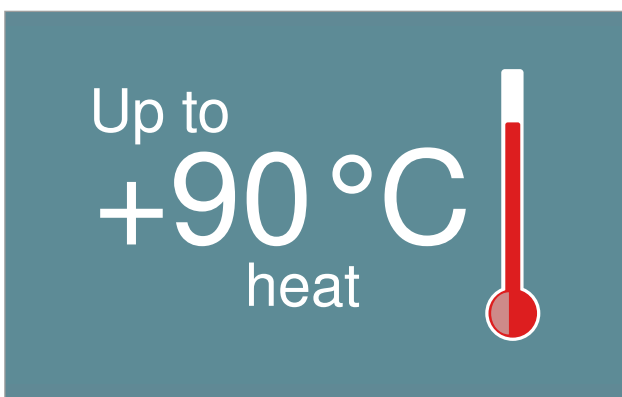

## Process, heating and service water

Compressor exhaust heat can be used to produce hot water with temperatures up to +90 °C, which can then be used for a wide range of applications.



## Space heating with hot exhaust air

Heating made easy: Thanks to radial fans with high residual thrust, the reusable (hot) air from air-cooled CSG-2 systems can easily be ducted away to spaces that require heating – usually without the need for additional fans.

# Technical implementation of integrated heat recovery

CSG - Water-cooled version with heat recovery

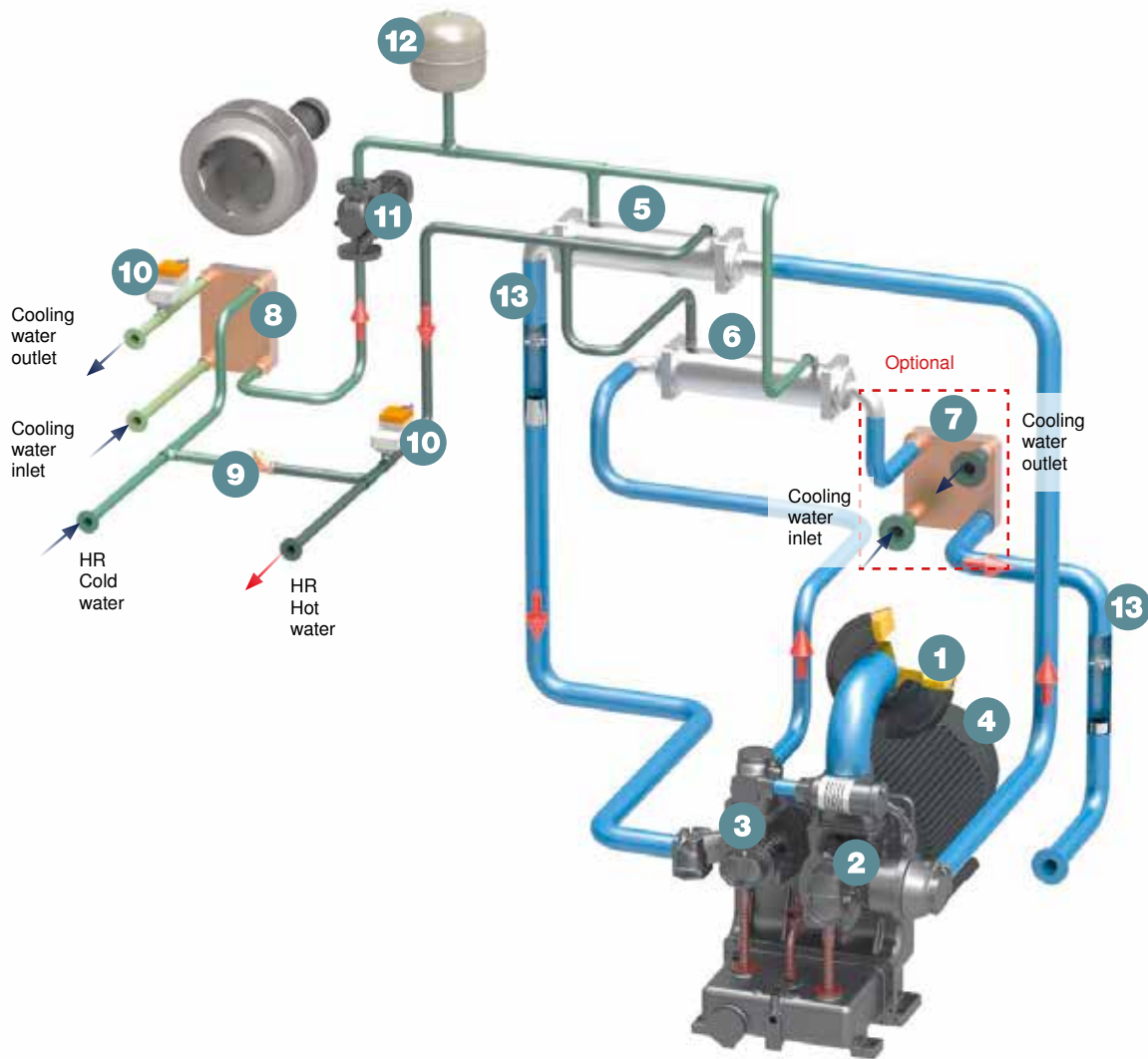

- |  |   |
|--|---|
| (1) Inlet filter   | (8) Heat exchanger (water/water)                        |
| (2) Low pressure stage (Stage 1)   | (9) Check valve   |
| (3) High pressure stage (Stage 2)  | (10) Water control valve<br>(actuated by SIGMA CONTROL) |
| (4) Drive motor  | (11) Pump   |
| (5) Air cooler downstream from Stage 1 (air/water)   | (12) Expansion tank                                     |
| (6) Air cooler downstream from Stage 2 (air/water)   | (13) Condensate separator                               |
| (7) Optional additional heat exchanger (air/water)<br>→ Version as plate-type heat exchanger | (14) Integrated i.HOC rotation dryer                    |

In two-stage dry compression rotary screw compressors, some 90% of the usable heat is processed through the two air coolers (5) and (6).

KAESER therefore uses separate, high-quality heat exchangers developed specially to meet heat recovery requirements. The remaining 10% of usable heat is processed through the oil cooler and in the jacket cooling system of the compression stages.



### Versions with rotation dryer

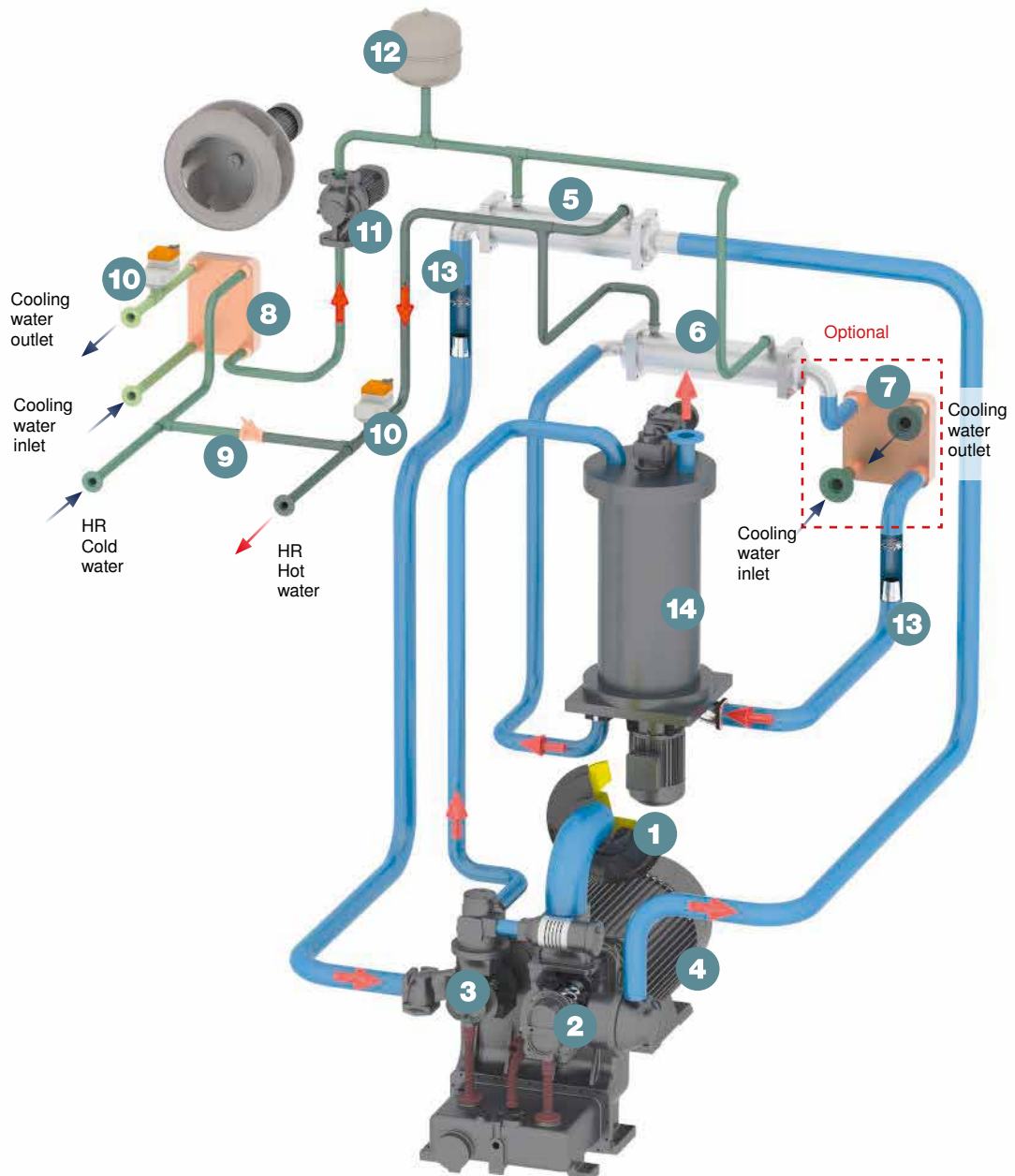

# Compressed air drying process - Overview



Refrigeration dryer

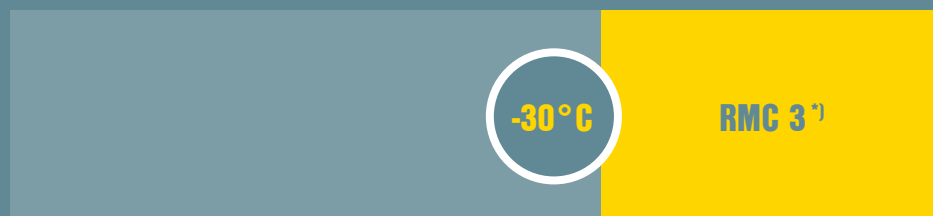

i.HOC rotation dryer

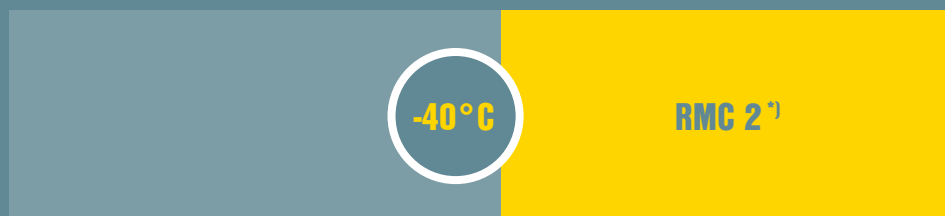

Combination dryer



Desiccant dryer



Residual moisture in the compressed air following drying.

\*) RMC = Residual Moisture Class



# Precision analysis essential

The required pressure dew point plays a significant role in determining the drying process, as well as the investment, service and energy costs associated with compressed air drying.

It is therefore highly recommended to carry out a detailed system analysis. Unnecessarily high compressed air volumes create additional costs, which is something that we will gladly help you avoid!



## Refrigeration dryer

For oil-free compression rotary screw compressors, refrigeration dryers are the go-to choice for delivering best possible energy efficiency and favourable investment costs when pressure dew points down to **+3 °C** are required. Pressure dew points below **+3 °C** are provided by desiccant dryers.

## i.HOC rotation dryer

Integrated into the rotary screw compressor, the optional i.HOC rotation dryer can reliably and efficiently deliver pressure dew points down to **-30 °C**. The hot compressed air from the second compression stage is used to regenerate the desiccant.



## Combination dryer

HYBRITEC dryers combine the energy-saving operation of modern refrigeration dryers with the ultra-low pressure dew points of desiccant dryers. HYBRITEC dryers can deliver pressure dew points as low as **-40 °C** with exceptional efficiency.



## Heatless regenerating desiccant dryer

KAESER'S DC series heatless regenerating desiccant dryers deliver pressure dew points as low as **-70 °C**, even under extreme operating conditions.

# Integrated refrigeration drying

KAESER refrigeration dryers ensure dry compressed air that is perfectly suited for the intended application and all flow rates. With these high-quality industrial machines, you will be providing reliable protection against condensate damage for your systems and processes, even under the harshest of conditions.



## Energy-saving drying

An integrated design, together with the generously-dimensioned aluminium block heat exchanger, helps ensure a minimal pressure loss of less than 0.1 bar. The energy-saving scroll refrigerant compressor helps to achieve additional compressed air energy savings.



## Excellent accessibility

All refrigeration dryer components are perfectly accessible via the service door on the front of the unit. This makes servicing and maintaining the dryer a breeze.

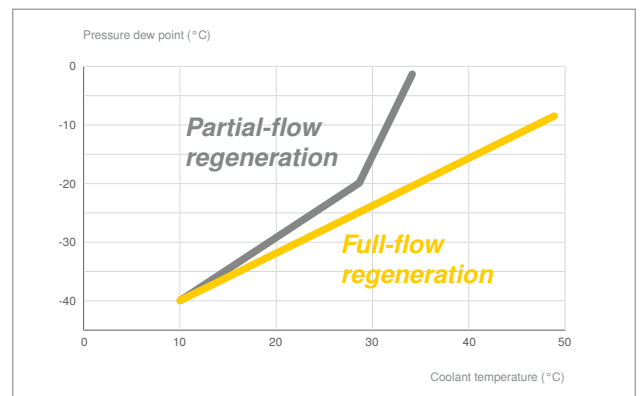
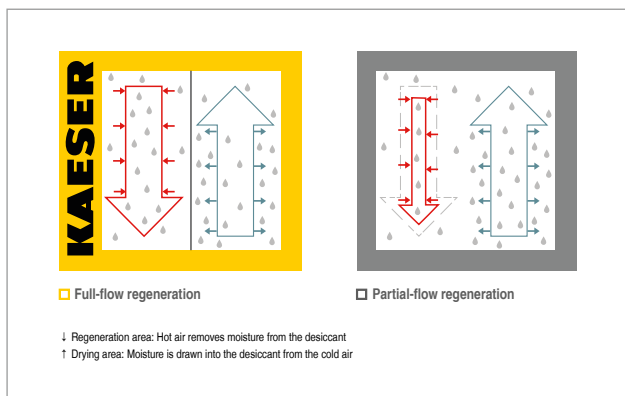



Image: CSG 120-2 T SFC A



Image: CSG 120-2 RD SFC, person shown 1.80 m tall



## Full-flow regeneration in detail

The i.HOC (Integrated Heat of Compression Dryer) system uses 100% of the heat of compression from the second compression stage for drying purposes (full-flow regeneration). This heat, which is produced in any case, is therefore effectively available at zero cost.

## Drying even near the limit

The advantages of full-flow regeneration become obvious, especially with increased coolant temperatures. KAESER rotation dryers achieve outstanding drying results, even without additional electrical heating of the regeneration air.



i.HOC

## Dependable pressure dew points thanks to innovative process engineering

The patented i.HOC rotation dryer from KAESER reuses up to 100% of the compression heat! Thanks to this full-flow regeneration, it can deliver reliable pressure dew points up to an ambient temperature of +45 °C – without any electrical heating or additional cooling of the regeneration air. Both air and water-cooled versions are available.

### The benefits:

- Dependable sub-zero pressure dew points even at high ambient or coolant temperatures.
- Pressure dew point stability even at the lowest compressor loads – without any need for a partial load compensator.
- Available with pressure dew point control if required.
- Highly effective drying and heat recovery on water-cooled compressors.



### Perfect performance

The i.HOC rotation dryer's intelligent control ensures pressure dew point stability even with fluctuating flow rates and at partial compressor load. When commissioned, the target pressure dew point is reached after just one rotation of the drum.

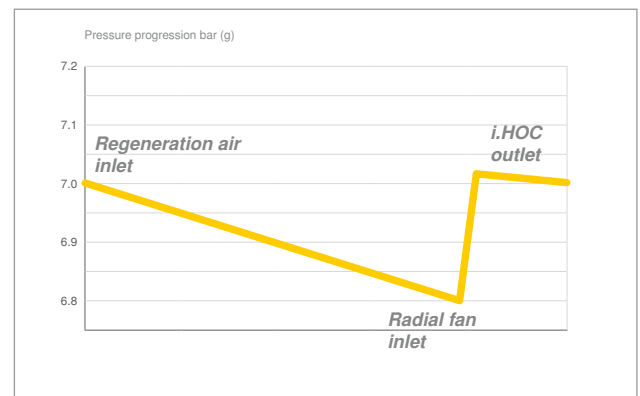

### Pressure loss? On the contrary!

The radial fan in the base of the rotation dryer equalises drying process pressure losses as needed, thereby guaranteeing maximum pressure dew point stability and quality - the pressure at the i.HOC dryer outlet is even higher than that at the inlet.



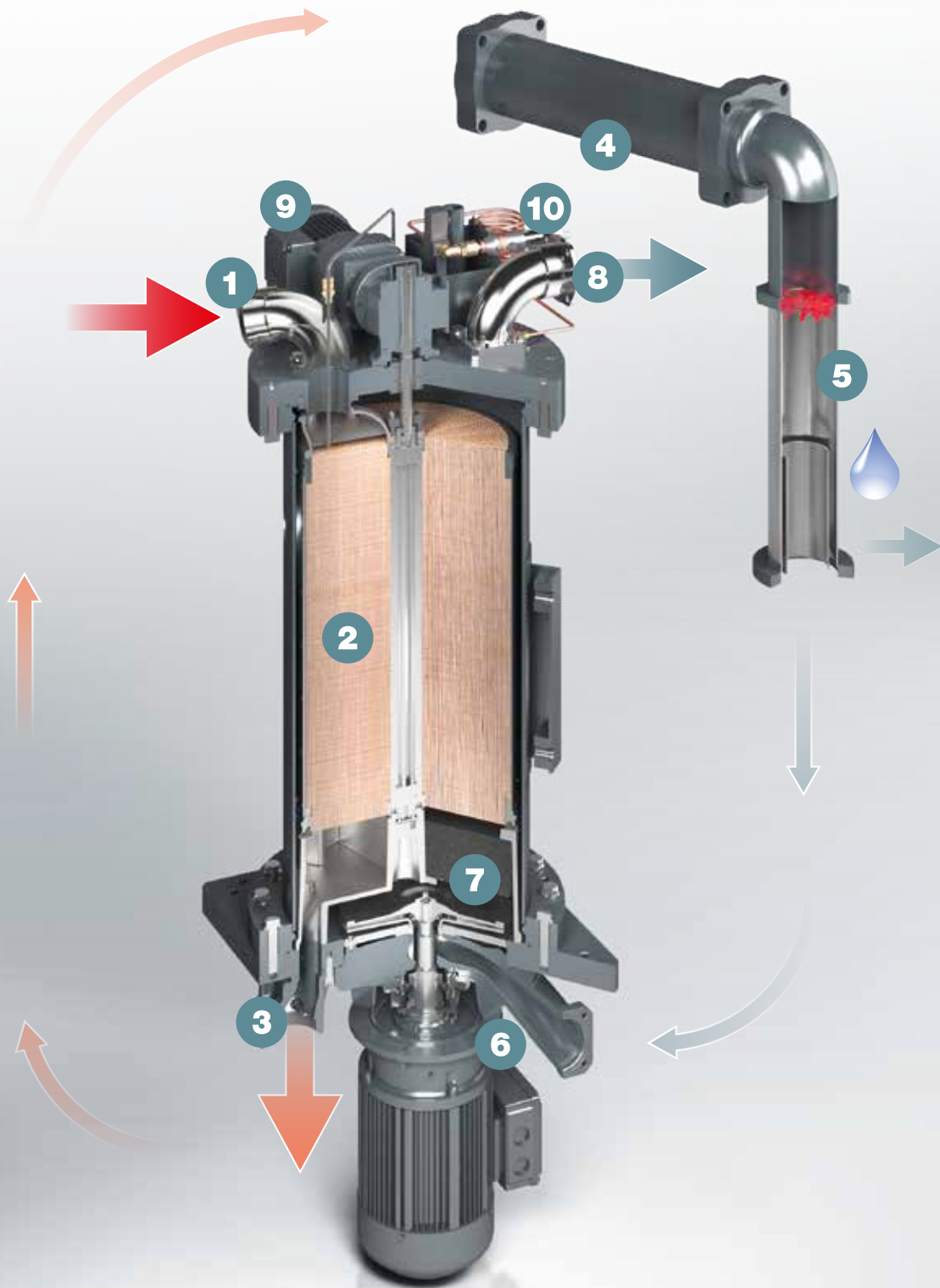

Image: RD 130 rotation dryer

- |                             |   |
|-----------------------------|---|
| (1) Regeneration air inlet  | (6) Radial fan                            |
| (2) Drum                    | (7) Demister                              |
| (3) Regeneration air outlet | (8) i.HOC rotation dryer outlet           |
| (4) Heat exchanger stage 2  | (9) Drum motor                            |
| (5) Condensate separator    | (10) Pressure dew point sensor (optional) |

# Precision operation for high efficiency and low pressure dew points



## Precision drum

The silica gel desiccant is bedded in a precision-manufactured drum with exceptionally high run-out qualities. Incorrect flow within the dryer and the resulting pressure dew point fluctuations are therefore reliably prevented.



## Variable-speed drum motor

Drum speed is automatically adjusted according to actual compressor performance, so as to regenerate the desiccant as effectively as possible. This is the key to ensuring consistently low pressure dew points.



## Durable and efficient

Thanks to CFD optimisation, the flow-optimised radial fan installed in the base of the dryer efficiently compensates for the pressure losses in the i.HOC cooling path.

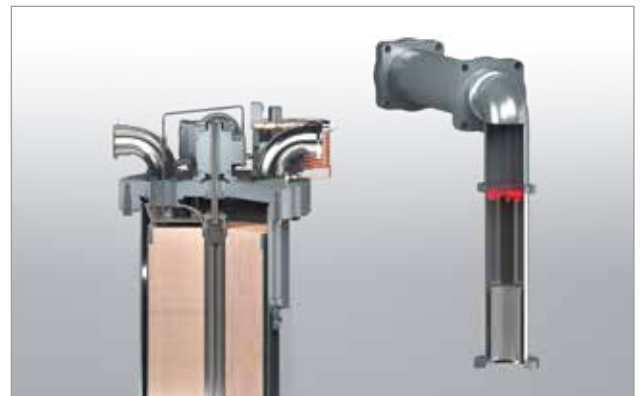

## External condensate separation

The i.HOC system uses a highly efficient condensate separator downstream from the heat exchanger in the second compression stage, so as to separate the condensate formed during the regeneration process **outside the dryer**. This protects the drum from potentially damaging water droplets.

Technical expertise

# Air-cooled CSG packages

## Standard versions

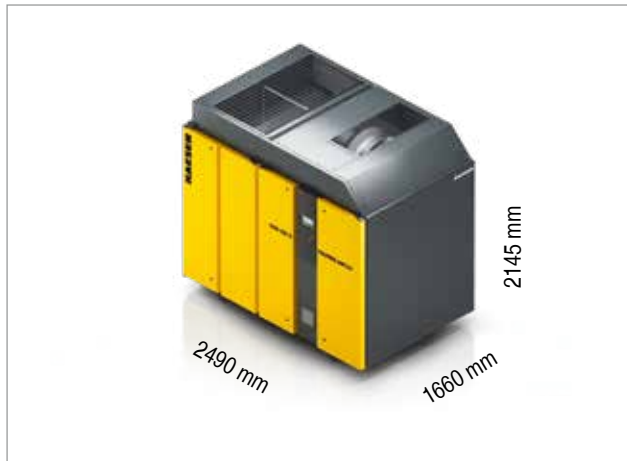

## How it works



## Versions with rotation dryer



## How it works



## Versions with dryer



## How it works



- |                         |  |                                      |
|-------------------------|--|--------------------------------------|
| (1) Inlet filter        | (4) Air cooler downstream from Stage 1 (air/water) | (7) Standstill fan                   |
| (2) Low pressure stage  | (5) Air cooler downstream from Stage 2 (air/water) | (8) i.HOC rotation dryer, integrated |
| (3) High pressure stage | (6) Oil cooler                                     | (9) Refrigeration dryer, integrated  |

Rated motor power	Gauge pressure	Standard					SFC with synchronous reluctance motor				
		Model	Flow rate complete system at max. gauge pressure <sup>1)</sup>	Pressure dew point <sup>2)</sup>	Sound pressure level <sup>2)</sup>	Mass	Model	Flow rate complete system at max. gauge pressure <sup>1)</sup>	Pressure dew point <sup>2)</sup>	Sound pressure level <sup>2)</sup>	Mass
kW	bar		m <sup>3</sup> /min	°C	dB(A)	kg		m <sup>3</sup> /min	°C	dB(A)	kg

### Standard versions

37	4 6 8	CSG 55-2	Upon request Upon request 5.40	-	71	2270	-	-	-	-	-
45	4 6 8 9	CSG 70-2	8.92 7.77 6.65 Upon request	-	71	2310	CSG 70-2 SFC <sup>4)</sup>	2.77 - 8.80 3.12 - 7.71 3.47 - 6.62 3.62 - 6.05	-	71	2360
55	4 6 8 9	CSG 90-2	10.52 9.62 8.80 7.69	-	72	2375	CSG 90-2 SFC	3.32 - 10.73 3.23 - 9.58 3.47 - 8.32 3.62 - 7.77	-	72	2360
75	4 6 8 10	CSG 120-2	12.97 12.92 12.00 10.43	-	73	2515	CSG 120-2 SFC	3.94 - 13.50 4.51 - 12.41 3.98 - 11.30 4.81 - 10.10	-	73	2400
90	4 6 8 10	CSG 130-2	- - 12.88 12.85	-	74	2640	CSG 130-2 SFC	4.23 - 13.52 4.64 - 13.41 5.05 - 13.30 5.47 - 12.70	-	74	2480

### Versions with rotation dryer

37	6 8	CSG 55-2	Upon request 5.40	Upon request -36	71	2985	-	-	-	-	-
45	6 8 9	CSG 70-2	7.77 6.65 Upon request	-28 -35 Upon request	71	3025	CSG 70-2 SFC <sup>4)</sup>	3.12 - 7.71 3.47 - 6.62 3.62 - 6.05	-28 -35 -36	71	3080
55	6 8 9	CSG 90-2	9.62 8.80 7.69	-25 -33 -36	72	3090	CSG 90-2 SFC	3.23 - 9.58 3.47 - 8.32 3.62 - 7.77	-25 -33 -35	72	3080
75	6 8 10	CSG 120-2	12.92 12.00 10.43	-19 -29 -34	73	3230	CSG 120-2 SFC	4.51 - 12.41 3.98 - 11.30 4.81 - 10.10	-21 -30 -34	73	3120
90	6 8 10	CSG 130-2	- 12.88 12.85	- -28 -32	74	3355	CSG 130-2 SFC	4.64 - 13.41 5.05 - 13.30 5.47 - 12.70	-20 -28 -32	74	3200

### Versions with dryer

37	4 6 8	CSG 55-2	Upon request Upon request 5.40	3	71	2520	-	-	-	-	-
45	4 6 8 9	CSG 70-2	8.92 7.77 6.65 Upon request	3	71	2560	CSG 70-2 SFC <sup>4)</sup>	2.77 - 8.80 3.12 - 7.71 3.47 - 6.62 3.62 - 6.05	3	71	2610
55	4 6 8 9	CSG 90-2	10.52 9.62 8.80 7.69	3	72	2625	CSG 90-2 SFC	3.32 - 10.78 3.23 - 9.58 3.47 - 8.32 3.62 - 7.77	3	72	2610
75	4 6 8 10	CSG 120-2	12.97 12.92 12.00 10.43	3	73	2765	CSG 120-2 SFC	3.94 - 13.50 4.51 - 12.41 3.98 - 11.30 4.81 - 10.10	3	73	2650
90	4 6 8 10	CSG 130-2	- - 12.88 12.85	3	74	2890	CSG 130-2 SFC	4.23 - 13.52 4.64 - 13.41 5.05 - 13.30 5.47 - 12.70	3	74	2730

<sup>1)</sup> Flow rate complete system as per ISO 1217:2009 Annex C/E: absolute inlet pressure 1 bar (a), cooling and air inlet temperature +20 °C 0 % rel. humidity <sup>2)</sup> Sound pressure level as per ISO 2151 and basic standard ISO 9614-2, tolerance: ± 3 dB(A), measured at maximum pressure and maximum speed

<sup>3)</sup> Pressure dew point at inlet valve 1 bar (a); cooling and air inlet temperature +20 °C; relative humidity 60%, cooling water outlet temperature +30 °C

<sup>4)</sup> CSG 70-2 SFC: Version with rated motor power 55kW

Specifications subject to change without notice.

Technical expertise

# Water-cooled CSG packages

## Standard versions

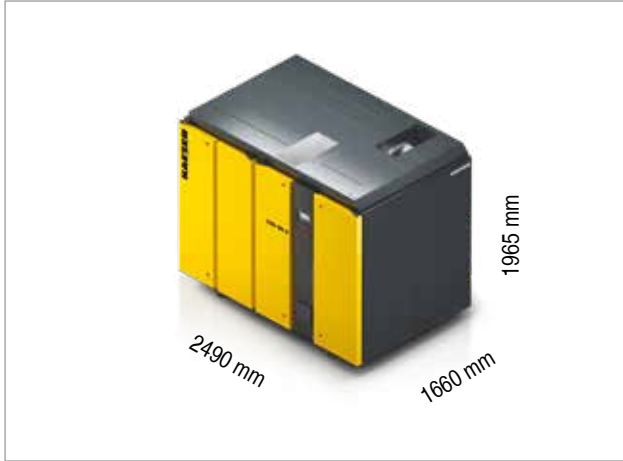

## How it works



## Versions with rotation dryer



## How it works

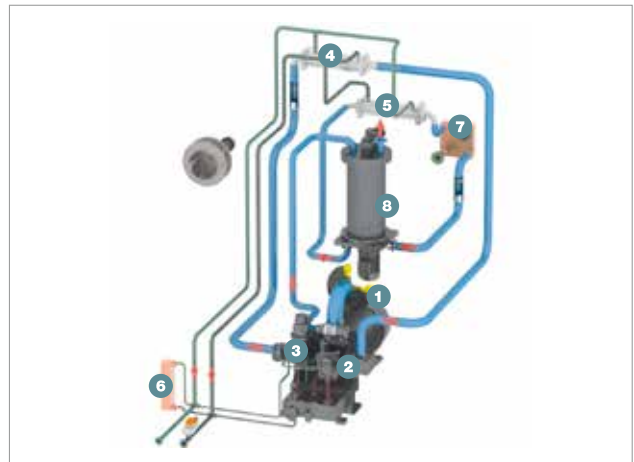

## Versions with dryer



## How it works



- |                         |  |  |
|-------------------------|--|--|
| (1) Inlet filter        | (4) Air cooler downstream from Stage 1 (air/water) | (7) Auxiliary heat exchanger downstream from Stage 2 air cooler (optional) |
| (2) Low pressure stage  | (5) Air cooler downstream from Stage 2 (air/water) | (8) i.HOC rotation dryer, integrated                                       |
| (3) High pressure stage | (6) Oil cooler                                     | (9) Refrigeration dryer  |



Rated motor power	Gauge pressure	Standard					SFC with synchronous reluctance motor				
		Model	Flow rate complete system at max. gauge pressure <sup>1)</sup>	Pressure dew point <sup>2)</sup>	Sound pressure level <sup>2)</sup>	Mass	Model	Flow rate complete system at max. gauge pressure <sup>1)</sup>	Pressure dew point <sup>2)</sup>	Sound pressure level <sup>2)</sup>	Mass
			m <sup>3</sup> /min	°C	dB(A)	kg		m <sup>3</sup> /min	°C	dB(A)	kg

### Standard versions

37	4 6 8	CSG 55-2	Upon request Upon request 5.57	-	64	2270	-	-	-	-	-
45	4 6 8 9	CSG 70-2	9.05 7.92 6.82 Upon request	-	64	2310	CSG 70-2 SFC <sup>4)</sup>	3.03 - 9.08 3.03 - 8.03 3.03 - 6.98 3.71 - 6.00	-	64	2360
55	4 6 8 10	CSG 90-2	10.67 9.78 8.97 7.83	-	65	2375	CSG 90-2 SFC	3.49 - 10.98 3.62 - 9.90 3.84 - 8.70 3.96 - 7.67	-	65	2360
75	4 6 8 10	CSG 120-2	13.10 13.07 12.15 10.58	-	66	2515	CSG 120-2 SFC	4.20 - 13.75 4.18 - 12.74 4.21 - 11.69 4.23 - 10.63	-	66	2400
90	4 6 8 10	CSG 130-2	- - 13.03 13.00	-	68	2640	CSG 130-2 SFC	4.40 - 13.48 4.33 - 13.51 4.26 - 13.54 4.20 - 13.08	-	68	2480

### Versions with rotation dryer

37	6 8 10	CSG 55-2	Upon request 5.57 -	Upon request -33 -	64	2985	-	-	-	-	-
45	6 8 10	CSG 70-2	7.92 6.82 Upon request	-25 -32 Upon request	64	3025	CSG 70-2 SFC <sup>4)</sup>	3.03 - 8.03 3.03 - 6.98 3.71 - 6.00	-25 -32 -35	64	3080
55	6 8 10	CSG 90-2	9.78 8.97 7.83	-23 -31 -35	65	3090	CSG 90-2 SFC	3.62 - 9.90 3.84 - 8.70 3.96 - 7.67	-23 -31 -35	65	3080
75	6 8 10	CSG 120-2	13.07 12.15 10.58	-20 -29 -34	66	3230	CSG 120-2 SFC	4.18 - 12.74 4.21 - 11.69 4.23 - 10.63	-21 -29 -34	66	3120
90	6 8 10	CSG 130-2	- 13.03 13.00	- -28 -33	68	3355	CSG 130-2 SFC	4.33 - 13.51 4.26 - 13.54 4.20 - 13.08	-20 -28 -33	68	3200

### Versions with dryer

37	4 6 8 10	CSG 55-2	Upon request Upon request 5.57 -	3	64	2520	-	-	-	-	-
45	4 6 8 10	CSG 70-2	9.05 7.92 6.82 Upon request	3	64	2560	CSG 70-2 SFC <sup>4)</sup>	3.03 - 9.08 3.03 - 8.03 3.03 - 6.98 3.71 - 6.00	3	64	2610
55	4 6 8 10	CSG 90-2	10.67 9.78 8.97 7.83	3	65	2625	CSG 90-2 SFC	3.49 - 10.98 3.62 - 9.90 3.84 - 8.70 3.96 - 7.67	3	65	2610
75	4 6 8 10	CSG 120-2	13.10 13.07 12.15 10.58	3	66	2765	CSG 120-2 SFC	4.20 - 13.75 4.18 - 12.74 4.21 - 11.69 4.23 - 10.63	3	66	2650
90	4 6 8 10	CSG 130-2	- - 13.03 13.00	3	68	2890	CSG 130-2 SFC	4.40 - 13.48 4.33 - 13.51 4.26 - 13.54 4.20 - 13.08	3	68	2730

<sup>1)</sup> Flow rate complete system as per ISO 1217:2009 Annex C/E: absolute inlet pressure 1 bar (a), cooling and air inlet temperature +20 °C 0 % rel. humidity <sup>2)</sup> Sound pressure level as per ISO 2151 and basic standard ISO 9614-2, tolerance: ± 3 dB(A), measured at maximum pressure and maximum speed

<sup>3)</sup> Pressure dew point at inlet valve 1 bar(a); cooling and air inlet temperature +20 °C; relative humidity 60%; cooling water outlet temperature +30 °C

<sup>4)</sup> CSG 70-2 SFC: Version with rated motor power 55kW

Specifications subject to change without notice.

# Equipment

## Complete system

Oil-free compression rotary screw compressor with two-stage compression; condensate separator, condensate drain and fibre-free pulse dampers for both compression stages; oil tank ventilation with microfilter, ready to operate, fully automatic, silenced.

## Airend

Two-stage oil-free compression rotary screw airend with integrated gearing and collection tank for gear oil; rotors with durable coating; both high and low pressure compression stages feature jacket cooling; high pressure stage with chromium steel rotors.

### Drive:

Precision gearing as per AGMA Q13/DIN Class 5 with helical spur gears.

## Drive motors

Base load versions: Premium Efficiency drive motor (IE4),  
Peak load versions: Synchronous reluctance motor (IES2), quality manufacture;  
IP 55 protection, Pt100 temperature sensor in windings; continuous measurement and monitoring of motor windings temperature.

## Electrical components

Ventilated IP 54 control cabinet, automatic star-delta starter, overload relay, control transformer.

## SIGMA CONTROL 2

Full-text display, 30 selectable languages; soft-touch icon keys; "traffic light" style LEDs to indicate operating status; fully automatic monitoring and control; Dual, Quadro and Dynamic control modes selectable as standard; SD card slot for data logging and updates; RFID reader; web server; interfaces: Ethernet; optional communications modules for: Profibus DP, Modbus, Profinet and Devicenet.

## Dynamic Control

The Dynamic Control feature calculates run-on times based on the motor windings temperature, which is measured by a sensor in the windings. This reduces idling times and cuts energy consumption. Additional control options are stored in the SIGMA CONTROL 2 and can be called up as required.

## Cooling

Air or water-cooling available; radial fan with separate drive motor; exhaust air discharged upwards.

### Air-cooled version:

High-pressure side: aluminium cooler with stainless steel tube pre-cooler. Low pressure side: aluminium cooler; aluminium cooler for gear oil.

### Water-cooled version:

Two shell and tube heat exchangers comprising coated steel jacket and pipes made from CuNi10Fe; one gear oil cooler.

## Dependable oil reservoir venting

The microfilter in the oil reservoir venting system prevents intake of oil-laden air. This is another key detail to ensure that compressed air quality is reliably and efficiently maintained at all times.

- (1) Microfilter
- (2) Oil mist removal
- (3) Ejector
- (4) Return to gear oil reservoir

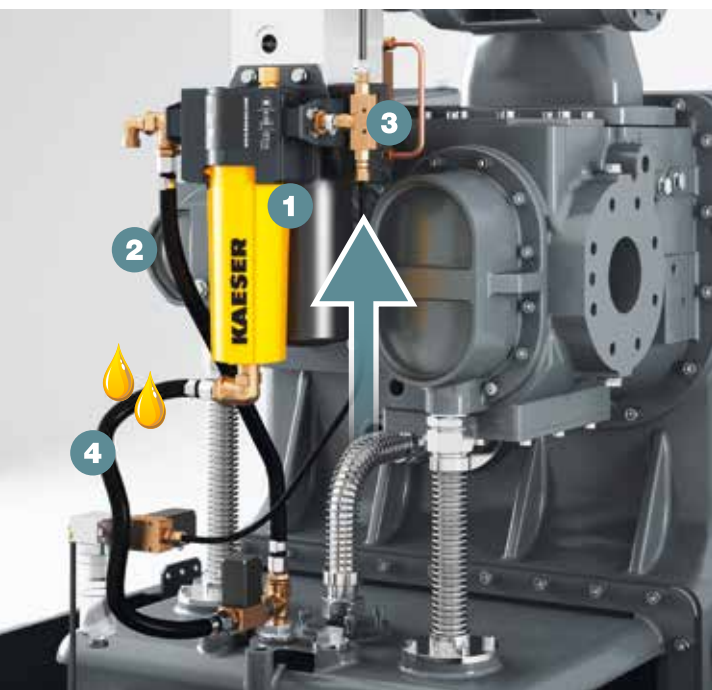

# Options

	Model	Air-cooled	Water-cooled
<b>Adjustable machine feet</b>	CSG-2	●	●
<b>Silencer, air inlet opening</b> (Sound-insulated connecting links upstream from heat exchangers)	CSG-2	●	–
<b>Cooling-air filter mats</b> (Protects the heat exchanger against heavy contamination)	CSG-2	●	–
<b>Integrated heat recovery with pump</b> (Compressor is equipped with a complete second auxiliary water system, including water pump. This protects the compressor against excessive temperatures.)	CSG-2	–	●
<b>Integrated heat recovery without pump</b> (Compressor is equipped with a second auxiliary water system, without water pump. This protects the compressor against excessive temperatures.)	CSG-2	–	●
<b>Auxiliary heat exchanger downstream from air cooler, 2nd stage</b> (Reduces the compressed air discharge temperature in compressors with heat recovery. Improves the pressure dew point for compressors with i.HOC.)	CSG-2	–	●
<b>Integrated heat exchanger downstream from i.HOC rotation dryer</b> (Reduces the compressed air discharge temperature from the compressor in packages with integrated i.HOC.)	CSG-2	●	●
<b>Pressure dew point measurement</b> (Pressure dew point sensor installed.)	CSG-2	●	●
<b>Pressure dew point adjustment</b> (Controlled bypass around the stage 1 heat exchanger to improve pressure dew point as needed.)	CSG-2	●	●
<b>Pressure dew point control</b> (Pressure dew point measurement and controlled bypass around the stage 1 heat exchanger to improve pressure dew point as needed.)	CSG-2	●	●
<b>KAESER hot air control</b> (Bypass around the stage 1 heat exchanger to increase compressed air temperature after leaving the 2nd stage, as needed. No heat exchanger installed downstream from the 2nd stage.)  <i>Not available for packages with integrated rotation or refrigeration dryer.</i>	CSG-2	●	●

- Available
- Not available

# The world is our home

As one of the world's largest compressed air system providers and compressor manufacturers, KAESER KOMPRESSOREN is represented throughout the world by a comprehensive network of branches, subsidiary companies and authorised partners in over 100 countries.

With innovative products and services, KAESER KOMPRESSOREN's experienced consultants and engineers help customers to enhance their competitive edge by working in close partnership to develop progressive system concepts that continuously push the boundaries of performance and compressed air efficiency.

Moreover, the decades of knowledge and expertise from this industry-leading system provider are made available to each and every customer via the KAESER group's global computer network.

These advantages, coupled with KAESER's worldwide service organisation, ensure that every product operates at the peak of its performance at all times and provides maximum availability.



EMINENT POWER ENGINEERING PVT LTD  
Regd. Office : 871/B1/D, GIDC Industrial Estate,  
Near Himalaya Char Rasta, Makarpura, Vadodara-390 010.  
Ph : +91 9824459599, Email : [info@eminentpowerepl.com](mailto:info@eminentpowerepl.com),  
Website : [www.eminentpowerepl.com](http://www.eminentpowerepl.com)